

LISTEN.
THINK.
SOLVE.SM

ArmorPoint I/O

SELECTION GUIDE



1738 SERIES



The ArmorPoint I/O System

ArmorPoint™ I/O has three major components:

- **I/O modules** provide the field interface, system-interface circuitry, and bases for mounting
- **Communication interface modules** provide the network-interface circuitry
- **Power distribution modules** provide the solution to expandability of the ArmorPoint I/O system and the flexibility to mix a variety of signal types



ArmorPoint I/O Features

- Highly modular design (1 pt — 8 pt modularity)
- Broad application coverage
- Channel-level diagnostics (LED and electronic)
- Channel-level alarm and annunciation (electronic)
- Channel-level open-wire detection with electronic feedback
- Channel-level short-circuit detection with electronic feedback
- Parameter-level explicit messaging
- Removal and insertion under power (RIUP)
- DeviceNet™ expansion
- Horizontal and vertical mounting without derating
- 5g vibration
- Flash upgradable adapters and digital I/O
- Electronic and mechanical keying
- Robust backplane design
- Hot swapping of I/O modules
- Quick-disconnects for I/O and network connectivity
- Built-in panel grounding
- Color-coded module labels
- UL, C-UL, and CE certifications (as marked)
- Highly reliable structural integrity
- Optical isolation between field and system circuits

ArmorPoint I/O Product Compatibility

The following chart illustrates the compatibility of ArmorPoint I/O with other control platforms, especially within Rockwell Automation. For information regarding the differences between the networks and ArmorPoint I/O, please refer to the Selecting a Network Interface section in this document.

	1738-ADN(X)	1738-ACNR	1738-AENT	1738-APB
PLC-5™ with Network Port	IOD	NS	NS	NA
SLC 500™ with Network Port	IOD	NS	NS	NA
PLC-5 Processor via Network Module	IOD	NS	NS	3
1756 Logix™ Communication Interface	IOD	IOD	IOD	3
PanelView™ Terminal	NA	NA	NA	NA
RSLinx™ Software	NA	NA	NA	NA
1769-L20, -L30 Controller with 1761-NET Interface	NA	NS	NS	NA
1769-L35E	NA	NA	IOD	NA
SoftLogix5800™	NS	NS	NS	NA
PC with RSLinx Only	NS	NS	NS	NA

IOD = I/O Data
 NS = Not Supported
 NA = Not Applicable
 3 = Requires third party scanner module

Communication Considerations

ArmorPoint I/O features are impacted by your network choice.

Network	Impact
DeviceNet 1738-ADN12, -ADN18, -ADN18P, and -ADNX	<p>The 1738-ADN12, -ADN18, and -ADN18P provide three means of connecting a node of I/O to DeviceNet.</p> <p>The 1738-ADNX expansion network port allows for a DeviceNet subnet.</p> <p>A total of 63 ArmorPoint I/O modules can be assembled on a single DeviceNet node.</p> <p>Expansion power supplies may be used to provide additional POINTBus backplane current.</p>
ControlNet™ 1738-ACNR	<p>A total of 63 ArmorPoint I/O modules can be assembled on a single ControlNet node.</p> <p>Expansion power supplies may be used to provide additional POINTBus backplane current.</p> <p>Up to 25 direct connections and 5 rack connections are allowed.</p>
EtherNet/IP™ 1738-AENT	<p>A total of 63 ArmorPoint I/O modules can be assembled on a single EtherNet/IP node.</p> <p>Expansion power supplies may be used to provide additional POINTBus backplane current.</p> <p>Refer to the User Manual, publication 1738-UM004 to determine the ratings for direct and rack connections allowed.</p>
PROFIBUS DP™ 1738-APB	<p>A total of 63 ArmorPoint I/O modules can be assembled on a single PROFIBUS node.</p> <p>Expansion power supplies may be used to provide additional POINTBus backplane current.</p>

Specifying an ArmorPoint I/O System

Follow these steps as you specify your ArmorPoint I/O system:

✓	Step	See Page
	<p>1 Select a communication interface</p> <p>Choose the interface module for your operating system.</p>	<p>NetLinx™ architecture 6</p> <p>Selecting a network 7</p> <p>Selecting the DeviceNet communication interface 8</p>
	<p>2 Select I/O devices based on field devices</p> <ul style="list-style-type: none"> • Location of the device • Number of ArmorPoint modules needed • Appropriate catalog number • Number of I/O available per module • Number of modules 	<p>Digital I/O modules 12</p> <p>Analog, thermocouple, and RTD I/O modules 15</p> <p>Specialty I/O modules 20</p> <p>Counter I/O modules 23</p>
	<p>3 Select optional power components</p> <p>Choose optional components to extend backplane power or change the field power distribution source.</p>	<p>Field power distributor 26</p> <p>Expansion power unit 27</p> <p>Typical configurations 29</p>
	<p>4 Select optional accessories</p> <p>Choose expansion cable units, if necessary.</p>	<p>Accessories, Cables, and Cordsets 30</p>
	<p>5 Determine mounting requirement</p> <p>Determine necessary dimensions based on the communication interface chosen.</p>	<p>Placing ArmorPoint I/O modules 33</p> <p>Mounting the ArmorPoint I/O system 35</p>

Step 1 - Select:

- a communication interface module

Selecting ArmorPoint I/O Communication Interfaces

Separate communication interface adapters are available for different networks. Install adapters into the POINTBus backplane to allow ArmorPoint I/O modules to communicate with a controller.

NetLinx Architecture

NetLinx open network architecture is the Rockwell Automation strategy of using open networking technology for seamless, top-floor to shop-floor integration. The networks in the NetLinx architecture — DeviceNet, ControlNet, and EtherNet/IP — speak a common language and share a universal set of communication services. NetLinx architecture, part of the Integrated Architecture, seamlessly integrates all the components in an automation system from a few devices on one network to multiple devices on multiple networks including access to the Internet — helping you to improve flexibility, reduce installation costs, and increase productivity.

- EtherNet/IP is an open industrial networking standard that supports implicit and explicit messaging and uses commercial, off-the-shelf EtherNet equipment and physical media.
- ControlNet allows intelligent, high-speed control devices to share the information required for supervisory control, work-cell coordination, operator interface, remote device configuration, programming, and troubleshooting.
- DeviceNet offers high-speed access to plant-floor data from a broad range of plant-floor devices and a significant reduction in wiring.

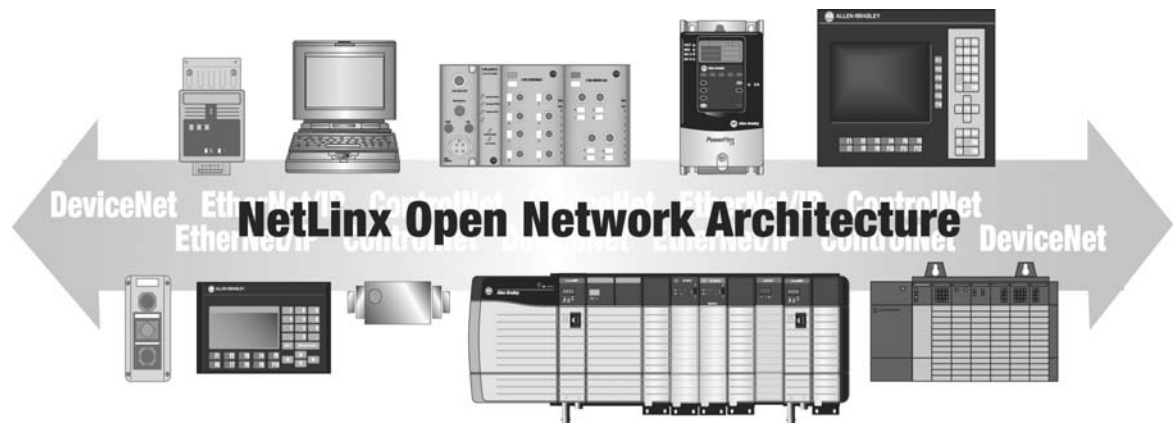

Selecting a Network

You can configure your system for information exchange between a range of devices and computing platforms and operating systems.

Application Requirements:	Network:	Select:
<ul style="list-style-type: none"> • Plant management (material handling) • Configuration, data collection, and control on a single, high-speed network • Time-critical applications with no established schedule • Data sent regularly • Internet/Intranet connection 	EtherNet/IP	1738-AENT
<ul style="list-style-type: none"> • High-speed transfer of time-critical data between controllers and I/O devices • Deterministic and repeatable data delivery • Media redundancy • Controller redundancy • Intrinsic safety • Redundant controller systems 	ControlNet	1738-ACNR
<ul style="list-style-type: none"> • Connections of low-level devices directly to plant-floor controllers, without interfacing them • Data sent as needed • More diagnostics for improved data collection and fault detection • Less wiring and reduced start-up time than a traditional, hard-wired system 	DeviceNet	1738-ADN12 1738-ADN18 1738-ADN18P 1738-ADNX
<ul style="list-style-type: none"> • Connecting to an existing PROFIBUS DP 5m bus, 12 MB network 	PROFIBUS	1738-APB

Selecting the DeviceNet Communication Interface

ArmorPoint I/O offers four interfaces for connecting to DeviceNet. Refer to the following table.

For These Features:	Remember:	Select:
<ul style="list-style-type: none"> Behaves as a slave device on the Main Network and a master on the POINTBus Allows a group of I/O modules on the Subnet to act as a single node on the Main Network RSNetWorx™ for DeviceNet software is needed for configuration of the 1738-ADN12, -ADN18, or -ADN18P on the Main Network and the POINTBus Configuration on the POINTBus consists of a scan list that is very similar to those used in all of the DeviceNet master scanner modules 	<ul style="list-style-type: none"> All ArmorPoint I/O modules count as a single node on the Main Network. The Main Network distance is acceptable. ArmorPoint I/O expansion power supplies are permitted to add more ArmorPoint I/O modules. 	1738-ADN12 (M12-style network connectors) 1738-ADN18 (mini-style network connectors) 1738-ADN18P (mini-style network connectors with pass-through)
<ul style="list-style-type: none"> Acts like a 1738-ADN12 or -ADN18, with additional capabilities Has a second, M12-style connector that extends the Subnet off the module, so that any DeviceNet-capable device could be connected to a subnet and scanned by the 1738-ADNX Node numbers of the devices on the POINTBus and subnet would not count against the 63 slave nodes allowed on the Main Network Data from these devices would be included in the data being sent to/from the 1738-ADNX on the main network Network on the second connector is electrically isolated from the Main Network and can be used to extend the total DeviceNet trunk line distance <p>For example: with thick round media at 125K baud, you could run a maximum of 500m to a 1738-ADNX on the Main Network. You could then wire an additional 500m of cable on the subnet connector and double the distance of the network. <i>Remember that this Subnet needs terminating resistors and a 24V dc power connection, the same as any other DeviceNet network.</i></p>	<ul style="list-style-type: none"> All ArmorPoint I/O modules and some third-party field devices count as a single node on the Main Network Devices on the Subnet and the Main Network need to be connected at different baud rate speeds or use different sampling methods (i.e., COS, polled, etc.) The Main Network distance is not acceptable, and additional distance is required. An expansion power supply may be required to add more modules. ArmorPoint I/O expansion power supplies are permitted. 	1738-ADNX

With the introduction of the 1738-232ASCM12 module, the amount of data to be transferred over the Subnet could become substantial. This could also occur with the 1738-ADNX and the standard DeviceNet devices connected to its Subnet connector. It is important that the total amount of data coming from the Subnet does not exceed the data capability of either the 1738-ADN12, -ADN18, -ADN18P, or -ADNX.

- 250 bytes (248 data + 2 bytes command info) for output data (used as either COS, cyclic, or poll)
- 250 bytes (248 data + 2 bytes status info) for polled input data
- 250 bytes (248 data + 2 bytes status info) for COS/cyclic input data
- 8 bytes (6 data + 2 status info) for strobe input data

The data coming through the 1738 adapter combined with the other data from the Main Network cannot exceed the data capability of the Main Network master scanner. If this occurs, you will need multiple master scanners on the Main Network and the I/O modules on the Subnet will need to be split between multiple 1738-ADN12, -ADN18, -ADN18P, or -ADNX adapters.

Step 2 - Select:

- I/O modules - some modules have diagnostic features, electronic fusing, or individually isolated inputs/outputs

Selecting ArmorPoint I/O Modules

The ArmorPoint I/O family provides a wide range of input and output modules to span many applications, from high-speed discrete to process control. ArmorPoint I/O supports producer/consumer technology, which allows input information and output status to be shared among multiple Logix controllers.



The ArmorPoint family of I/O modules includes:

- 1738 digital I/O modules
- 1738 analog I/O modules
- 1738 specialty I/O modules
- 1738 network communication adapters
- 1738 power supply
- 1738 backplane extenders

Digital I/O Modules

Choose digital I/O modules when you need:

- **Input modules.** An input module responds to an input signal in the following manner:
 - Input filtering limits the effect of voltage transients caused by contact bounce and/or electrical noise. If not filtered, voltage transients could produce false data. All input modules use input filtering.
 - Optical isolation shields logic circuits from possible damage due to electrical transients.
 - Logic circuits process the signal.
 - An input LED turns on or off indicating the status of the corresponding input device.

- **Output modules.** An output module controls the output signal in the following manner:
 - Logic circuits determine the output status.
 - An output LED indicates the status of the output signal.
 - Optical isolation separates module logic and bus circuits from field power.
 - The output driver turns the corresponding output on or off.

- **Surge suppression.** Most output modules have built-in surge suppression to reduce the effects of high-voltage transients. However, we recommend that you use an additional suppression device if an output is being used to control inductive devices, such as:
 - Relays
 - Motor starters
 - Solenoids
 - MotorsAdditional suppression is especially important if your inductive device is in series with or parallel to hard contacts, such as:
 - Push buttons
 - Selector switches

The 1738 digital I/O modules support:

- a wide variety of voltage interface capabilities
- isolated and non-isolated module types
- point-level output fault states
- choice of direct-connect or rack-optimized communications
- field-side diagnostics on select modules

Connector types are indicated by the catalog number. For example, the 1738-IB2M12 has an M12 connector.

Digital AC Input Modules

	1738-IA2M12AC3 1738-IA2M12AC4
Number of Inputs	2
Keyswitch Position	8
Voltage, On-State Input, Nom.	120V ac
Voltage, On-State Input, Min.	65V ac
Voltage, On-State Input, Max.	132V ac
Input Delay Time, ON to OFF, Hardware Delay, Max.	20 ms hardware filter plus 0...65 ms digital filter programmable in increments of 1 ms*
Current, On-State Input, Min.	3.7 mA
Input Impedance, Nom.	10.6 kΩ
Current, Off-State Input, Max.	2.5 mA
PointBus Current (mA)	75
Power Dissipation, Max.	0.7 W @ 132V ac

*Input ON-to-OFF delay time is the time from a valid input signal to recognition by the module.

Digital AC Output Module

	1738-OA2M12AC3
Number of Outputs	2
Keyswitch Position	8
Voltage, On-State Output, Nom.	120V ac, 220V ac
Voltage, On-State Output, Min.	74V ac
Voltage, On-State Output, Max.	264V ac
Output Current Rating	1.5 A (2 channels @ 0.75 A each)
PointBus Current (mA)	75
Power Dissipation, Max.	0.8 W @ 28.8V dc

Digital DC Input Modules

	1738-IB2M12	1738-IB4M8 1738-IB4M12	1738-IB8M8 1738-IB8M12 1738-IB8M23	1738-IV4M12	1738-IV8M8 1738-IV8M12 1738-IV8M23
Number of Inputs	2 Sinking	4 Sinking	8 Sinking	4 Sourcing	8 Sourcing
Keyswitch Position	1	1	1	1	1
Voltage, On-State Input, Nom.	24V dc	24V dc	24V dc	24V dc	24V dc
Voltage, On-State Input, Min.	10V dc	10V dc	10V dc	10V dc	10V dc
Voltage, On-State Input, Max.	28.8V dc	28.8V dc	28.8V dc	28.8V dc	28.8V dc
Input Delay Time, ON to OFF	0.5 ms hardware + (0...65 ms selectable)*	0.5 ms hardware + (0...65 ms selectable)*	0.5 ms hardware + (0...65 ms selectable)*	0.5 ms hardware + (0...65 ms selectable)*	0.5 ms hardware + (0...65 ms selectable)*
Current, On-State Input, Min.	2 mA	2 mA	2 mA	2 mA	2 mA
Current, On-State Input, Max.	5 mA	5 mA	5 mA	5 mA	5 mA
Current, Off-State Input, Max.	1.5 mA	1.5 mA	1.5 mA	1.5 mA	1.5 mA
PointBus Current (mA)	75	75	75	75	75
Power Dissipation, Max.	0.7 W @ 28.8V dc	1.0 W @ 28.8V dc	1.6 W @ 28.8V dc	1.0 W @ 28.8V dc	1.6 W @ 28.8V dc

*Input ON-to-OFF delay time is the time from a valid input signal to recognition by the module.

Digital DC Output Modules

	1738-OB2EM12	1738-OB2EPM12	1738-OB4EM8 1738-OB4EM12	1738-OB8EM8 1738-OB8EM12 1738-OB8M23	1738-OV4EM12
Number of Outputs	2	2	4	8	4
Keyswitch Position	1	1	1	1	1
Voltage, On-State Output, Nom.	24V dc	24V dc	24V dc	24V dc	24V dc
Voltage, On-State Output, Min.	10V dc	10V dc	10V dc	10V dc	10V dc
Voltage, On-State Output, Max.	28.8V dc	28.8V dc	28.8V dc	28.8V dc	28.8V dc
Output Current Rating, Max.	2.0 A per module, 1.0 A per channel	4.0 A per module, 2.0 A per channel	3.0 A per module, 1.0 A per channel	3.0 A per module, 1.0 A per channel	4.0 A per module, 1.0 A per channel
PointBus Current (mA)	75	75	75	75	75
Power Dissipation, Max.	0.8 W @ 28.8V dc	3.4 W @ 28.8V dc	1.2 W @ 28.8V dc	2.0 W @ 28.8V dc	2.9 W @ 28.8V dc

Digital Contact Output Modules

	1738-OW4M12 1738-OW4M12AC4
Number of Outputs	4 Form A (N.O.) relays, isolated
Keyswitch Position	7
Output Delay Time, ON to OFF, Max.	26 ms*
Contact Resistance, Initial	30 m Ω
Leakage Current, Off-State Output, Max.	1.2 mA and bleed resistor thru snubber circuit @ 240V ac
PointBus Current (mA)	80
Power Dissipation, Max.	0.5 W

*Time from valid output off signal to relay deenergization by module.

Analog, Thermocouple, and RTD I/O Modules

The ArmorPoint analog and temperature I/O modules support: on-board, channel-level data alarming (four set-points per channel); scaling to engineering units; channel-level diagnostics (electronic bits and LEDs); and integer format.

Choose analog, thermocouple, and/or RTD I/O modules when you need:

- **Individually configurable channels** to use the module(s) with a variety of sensors.
- **On-board scaling** to eliminate the need to scale the data in the controller. Controller processing time and power are preserved for more important tasks, such as I/O control, communications, or other user-driven functions.
- **On-line configuration.** Modules can be configured in the RUN mode using the programming software or the control program. This allows you to change configuration while the system is operating. For example, the input filter for a particular channel could be changed, or a channel could be disabled based on a batch condition. *To use this feature, the controller and network interface must also support this feature.*
- **Over- and under-range detections and indications.** This eliminates the need to test values in the control program, saving valuable processing power of the controller. In addition, since alarms are handled by the module, the response is faster and only a single bit per channel is monitored to determine if an error condition has occurred.
- **Ability to direct output device operation during an abnormal condition.** Each channel of the output module can be individually configured to hold its last value or assume a user-defined value on a fault condition. This feature allows you to set the condition of your analog devices, and therefore your control process, which may help to ensure a reliable shutdown.
- **Ability to individually enable and disable channels.** Disabling unused channels improves module performance.
- **Selectable input filters** This lets you select the filter frequencies for each channel that best meets the performance needs of your application based on environmental limitations. Lower filter settings provide greater noise rejection and resolution. Higher filter settings provide faster performance. *Note: The analog modules provide four input filter selections; RTD and thermocouple modules provide six.*
- **Selectable response to broken input sensor.** This feature provides feedback to the controller that a field device is not connected or operating properly. This lets you specify corrective action based on the bit or channel condition.
- **High accuracy.** The modules share a high accuracy rating of $\pm 0.1\%$ of full-scale accuracy at 25 °C.

Analog Input Modules

	1738-IE2CM12	1738-IE2VM12	1738-IR2M12*	1738-IT2IM12*
Number of Inputs	2	2	2	2
Keyswitch Position	3	3	6	6
Input Signal Range	4...20 mA 0...20 mA	0...10V ±10V	0...600 Ω	±75 mV
Input Resolution, Bits	16 bits - over 21 mA 0.32 μA/cnt	15 bits plus sign 320 μV/cnt in unipolar or bipolar mode	16 bits 9.5 mV/cnt 0.03 °C/cnt (pt 385 @ 25 °C)	15 bits plus sign 2.5 mV per count
Absolute Accuracy, Current Input	0.1% Full Scale @ 25 °C*	—	—	—
Absolute Accuracy, Voltage Input	—	0.1% Full Scale @ 25 °C *	0.1% Full Scale @ 25 °C*‡	0.1% Full Scale @ 25 °C*‡
Input Step Response, per Channel	70 ms @ Notch = 60 Hz (default) 80 ms @ Notch = 50 Hz 16 ms @ Notch = 250 Hz 8 ms @ Notch = 500 Hz	70 ms @ Notch = 60 Hz (default) 80 ms @ Notch = 50 Hz 16 ms @ Notch = 250 Hz 8 ms @ Notch = 500 Hz	—	—
Input Conversion Type	Delta Sigma	Delta Sigma	—	—
PointBus Current (mA)	75	75	220	175
Power Dissipation, Max.	0.6 W @ 28.8V dc	0.75 W @ 28.8V dc	1.0 W	1.0 W

*Includes offset, gain, non-linearity and repeatability error terms.

‡ Analog and temperature input modules support these configurable parameters and diagnostics: open-wire with LED and electronic reporting; four-alarm and annunciation set-points; calibration mode and electronic reporting; under- and over-range and electronic reporting; channel signal range and update rate and on-board scaling; filter-type; temperature scale; channel update rate.

Analog Output Modules

	1738-OE2CM12	1738-OE2VM12
Number of Outputs	2	2
Keyswitch Position	4	4
Output Signal Range	4...20 mA 0...20 mA	0...10V ±10V
Output Resolution, Bits	13 bits - over 21 mA 2.5 μA/cnt	14 bits (13 plus sign) 1.28 mV/cnt in unipolar or bipolar mode
Absolute Accuracy, Current Output	0.1% Full Scale @ 25 °C*‡	—
Absolute Accuracy, Voltage Output	—	0.1% Full Scale @ 25 °C *‡
Step Response to 63% of FS, Current Output	24 μs	—
Step Response to 63% of FS, Voltage Output	—	20 μs
Output Conversion Rate	16 μs	20 μs
PointBus Current (mA)	75	75
Power Dissipation, Max.	1.0 W @ 28.8V dc	1.0 W @ 28.8V dc

*Includes offset, gain, non-linearity and repeatability error terms.

‡ Analog output modules support these configurable parameters and diagnostics: open-wire with LED and electronic reporting (OE2C only); fault mode; idle mode; alarms; channel signal range and on-board scaling.

Temperature Module Alarms

ArmorPoint I/O temperature modules are capable of detecting and communicating the following electronic conditions:

- over-range alarm
- under-range alarm
- level alarm (low-low, low, high, high-high)
- open-wire alarm

Over-Range Alarm

The channel over-range alarm is set if the input is greater than the maximum temperature (thermocouple or RTD range dependent), millivolt (+75V) or resistance (600 Ω) range value, or above the maximum range of the thermocouple or RTD.

The cold-junction compensator has its own over-range alarm. If the CJC temperature goes above 70 °C, the over-range alarm is set.

Under-Range Alarm

The channel under-range alarm is set if the input is less than the minimum temperature (thermocouple or RTD range dependent), millivolt (-75 mV) or resistance (10 Ω) range value, or below the minimum range of the thermocouple or RTD.

The cold-junction compensator has its own under-range alarm. If the CJC temperature goes below 0 °C, the under-range alarm is set.

Level Alarms

There are four level alarms:

- low
- low-low
- high
- high-high

When the channel input goes below a low alarm or above a high alarm, a bit is set in the data table. All alarm status bits can be read individually or by reading the channel status byte (bits 2-5 for channel 0; bits 10-13 for channel 1).

Each channel alarm can be configured individually.

Open-Wire Alarm

The module has the ability to check for a broken or detached wire. In any mode, if a broken/detached lead is detected, the data value is forced to maximum and the over-range alarm is set. Once the alarm is issued, it remains active as long as the input signal is faulted.

Cold-Junction Compensation (1738-IT2IM12 Only)

When using thermocouples, cold-junction compensation is required at the termination of the thermocouple wire. Cold-junction can be accomplished in two ways:

- enter an estimated temperature
- an M12 terminal chamber with built-in CJC

To use the M12 terminal chamber, order 871A-TS4CJC-DM (straight) or 871A-TR4CJC-DM (right-angle)

Entering an estimated temperature is the least accurate way for cold-junction compensation.

An open cold-junction compensator sets the input point to the maximum temperature value for the selected input type, setting an alarm. Once the alarm is issued, it remains active as long as the input signal is faulted (above maximum).

Cold-Junction Enable (1738-IT2IM12 Only)

Set this bit to enable or disable the cold-junction linearization. If enabled, the proper cold-junction compensation value will be applied to the selected thermocouple. If disabled, the data (cold-junction temperature) will still be available but not applied to the input. A cold-junction value can be added using the cold-junction offset parameter.

You can select the type and amount of noise filtering on each individual channel:

- notch filter of analog to digital converter
- first-order, low-pass digital filter

Choose the filter that provides you with the update and step response that most closely matches your system requirements.

Noise Filtering (1738-IR2M12 Only)

ArmorPoint I/O Temperature Input Module Specifications

	1738-IR2M12	1738-IT2IM12
Number of Inputs	2	2
Input Resolution, Bits	—	—
Thermocouple Type and Resolution Average Over Span	—	Type B, 30...1820° C, 3 counts/ ° C Type C, 0...2315° C, 6 counts/ ° C Type E, -270...1000° C, 24 counts/ ° C Type J, -210...1200° C, 21 counts/ ° C Type K, -270...1372° C, 13 counts/ ° C Type N, -270...1300° C, 11 counts/ ° C Type R, -50...1768.1° C, 4 counts/ ° C Type S, -50...1768.1° C, 4 counts/ ° C Type T, -270...400° C, 15 counts/ ° C
Cold Junction Compensation	—	871A-TS4CJC-DM (Straight) or 871A-TR4CJC-DM (Right Angle)
Cold Junction Compensation Range	—	0...70 °C
Absolute Accuracy, Voltage Input	0.1% Full Scale @ 25 °C*⊛	0.1% Full Scale @ 25 °C*⊛
Accuracy Drift w/Temp., Current Input	30 ppm/°C	30 ppm/°C
Input Update Rate, per Module	20 ms @ Notch = 50 Hz 17 ms @ Notch = 60 Hz (default) 10 ms @ Notch = 100 Hz 8 ms @ Notch = 120 Hz 5 ms @ Notch = 200 Hz 4 ms @ Notch = 240 Hz 3 ms @ Notch = 300 Hz 3 ms @ Notch = 400 Hz 2 ms @ Notch = 480 Hz	20 ms @ Notch = 50 Hz 17 ms @ Notch = 60 Hz (default) 10 ms @ Notch = 100 Hz 8 ms @ Notch = 120 Hz 5 ms @ Notch = 200 Hz 4 ms @ Notch = 240 Hz 3 ms @ Notch = 300 Hz 3 ms @ Notch = 400 Hz 2 ms @ Notch = 480 Hz
Input Step Response, per Channel	60 ms @ Notch = 50 Hz 50 ms @ Notch = 60 Hz 30 ms @ Notch = 100 Hz 25 ms @ Notch = 120 Hz 15 ms @ Notch = 200 Hz 13 ms @ Notch = 240 Hz 10 ms @ Notch = 300 Hz 8 ms @ Notch = 400 Hz 6 ms @ Notch = 480 Hz	60 ms @ Notch = 50 Hz 50 ms @ Notch = 60 Hz 30 ms @ Notch = 100 Hz 25 ms @ Notch = 120 Hz 15 ms @ Notch = 200 Hz 13 ms @ Notch = 240 Hz 10 ms @ Notch = 300 Hz 8 ms @ Notch = 400 Hz 6 ms @ Notch = 480 Hz
Input Impedance	—	100 kΩ
Input Resistance	—	1 MΩ
Input Conversion Type	Delta Sigma	Delta Sigma
Input Common Mode Rejection Ratio	120 dB	120 dB
Normal Mode Rejection Ratio	100 dB ±3 db Notch filter: 13.1 Hz @ Notch = 50 Hz 15.7 Hz @ Notch = 60 Hz 26.2 Hz @ Notch = 100 Hz 31.4 Hz @ Notch = 120 Hz 52.4 Hz @ Notch = 200 Hz 62.9 Hz @ Notch = 240 Hz 78.6 Hz @ Notch = 300 Hz 104.8 Hz @ Notch = 400 Hz 125.7 Hz @ Notch = 380 Hz	-60 dB, -3 dB Notch filter: 13.1 Hz @ Notch = 50 Hz 15.7 Hz @ Notch = 60 Hz 26.2 Hz @ Notch = 100 Hz 31.4 Hz @ Notch = 120 Hz 52.4 Hz @ Notch = 200 Hz 62.9 Hz @ Notch = 240 Hz 78.6 Hz @ Notch = 300 Hz 104.8 Hz @ Notch = 400 Hz 125.7 Hz @ Notch = 380 Hz
Input Data Format	Signed integer	Signed integer
Overvoltage Protection, Inputs	No input protection	Input not overvoltage protected
Input Calibration	Factory calibrated	Factory calibrated
Keyswitch Position	6	6
PointBus Current (mA)	220	175
Power Dissipation, Max.	1.0 W	1.0 W
Thermal Dissipation, Max.	3.3 BTU/hr @ rated load	3.3 BTU/hr @ rated load
Isolation Voltage	50V rms	50V rms Isolation between individual channels
External DC Power Supply Voltage, Nom.	24V dc	—
External DC Power Supply Voltage Range	10...28.8V dc	—
External DC Power Supply Current	15 mA @ 24V dc	—

*Includes offset, gain, non-linearity and repeatability error terms.

⊛ Analog and temperature input modules support these configurable parameters and diagnostics: open-wire with LED and electronic reporting; four-alarm and annunciation set-points; calibration mode and electronic reporting; under- and over-range and electronic reporting; channel signal range and update rate and on-board scaling; filter-type; temperature scale; channel update rate.

Specialty I/O Modules

1738-232ASCM12 and 1738-485ASCM12

The 1738-232ASCM12 and -485ASCM12 serial-interface modules offer a serial-link communication interface solution for peripheral products with:

- RS-232 ports

use the 1738-232ASCM12

- RS-485 and RS-422 ports

use the 1738-485ASCM12

These modules allow a device with serial-interface output, i.e., bar code readers, to communicate up to 128 bytes of ASCII data onto any network supported by ArmorPoint I/O. Each module is a single-channel, full-duplex interface and is rated for up to 38.4 kbaud. LED indicators on the modules offer diagnostics for the module, ArmorPointBus backplane, and transmit/receive status indication.

1738-SSIM23

The 1738-SSIM23 module collects serial data from industrial absolute-position encoding sensors that use standard SSI protocol. The SSI module is inserted into an ArmorPoint I/O terminal base that provides common power, communications, and wiring connections for the SSI sensors.

ArmorPoint I/O ASCII Module Specifications

	1738-232ASCM12 1738-485ASCM12
Number of Serial Channels	1
Keyswitch Position	2 (specialty)
PointBus Current (mA)	75
Power Dissipation	1.75 W @ 28.8V dc
Serial Port Parameters	
Serial Character Framing	7N2, 7E1, 7O1, 8N1, 8N2, 8E1, 8O1, 7E2, 7O2
Serial Port Comm Speed	9600, 1200, 2400, 4800, 19.2 k, 38.4 k
Serial Port Receive from ASCII Device	
Number of Receive Chars, Max	1...128
Receive Record Start Mode	No, exclude, include start delimiter
Receive Start Delimiter	ASCII character
Receive Record End Mode	No, exclude, include end delimiter
Receive End Delimiter	ASCII character
Send (Produce) on DeviceNet to Master	
Receive String Data Type	Array, short_string, string
Pad Mode	Pad mode disabled, enabled
Pad Character	ASCII character
Receive Swap Mode	Disabled, 16-bit, 24-bit, 32-bit swap
DeviceNet Handshake Mode	Master/slave handshake, produce immediate
Produce Assembly Size	4...132
Serial Data Size	0...128 bytes
Receive Transaction ID	0...255
Serial Port Transmit to ASCII Device	
Number of Transmit Chars, Max	1...128
Transmit End Delimiter Mode	No, exclude, include end delimiter
Transmit End Delimiter Character	ASCII
Consume on DeviceNet from Master	
Consume String Data Type	Array, short_string, string
Transmit Swap Mode	Disabled, 16-bit, 24-bit, 32-bit swap
DeviceNet Record Header Mode	Transmit handshake/immediate
Consume Assembly Size	4...132
Serial Port Transmit/Explicit Messages from Configuration Tool	
Transmit Serial Data String Size	0...128 bytes
Transmitted Serial Data Length	0...128 bytes
Transmit Transaction ID	0...255
Serial Port Status	TX FIFO overflow, RX FIFO overflow, RX parity error, handshake error, new data flag

1738-SSIM23 Module Specifications

	1738-SSIM23
Number of SSI Channels	1
Keyswitch Position	2
PointBus Current (mA)	110
Power Dissipation, Max.	0.94 W
Isolation Voltage	Tested to 1250V ac for 60 s between each of these isolated areas: Logic side and field power Logic side and shield Shield and field power
External DC Power Supply Voltage, Nom.	24V dc
Encoder Type	Any absolute encoder supporting standard SSI protocol including linear, rotary, and optical distance measuring devices
SSI Data Rate	125 kHz, 250 kHz, 500 kHz, 1 MHz, 2 MHz (software selectable)
SSI Bits Per Word	2...31 (software selectable)
SSI Word Length	4 bytes (32 bits)
SSI Word Delay Time	16 μ s...64 ms (software selectable)*
SSI Features	Gray or binary code capable with gray to binary conversion, increasing or decreasing SSI count indication, 2 SSI word comparator values, SSI word latching with I1 input
SSI Cable Type	UL CM/AWM 2464/CSA Type CMG FT4 or similar cable utilizing shielded twisted pairs for D+/- and C+/- connections. See sensor manufacturer for actual cable required for the SSI sensor under use. I1 input can be wired separate from SSI cable.*
SSI Cable Length	Depends on desired SSI data rate: 125 kHz...1050 ft(320m) 250 kHz...525 ft(160m) 500 kHz...195 ft(60m) 1 MHz...65 ft(20m) 2 MHz...25 ft(8m)
SSI Sensor Power (At V+/- Terminals)	10...28.8V dc common with field power voltage, 0.75A dc maximum with short circuit protection
SSI Clock Drive Current, Max. (Out of C+/- Terminals)	750 mA
Input I1 Category/Type	Similar to IEC Type 3, sourcing
Voltage, On-State Input, Min.	0V dc
Voltage, On-State Input, Max.	Field Power Supply Voltage minus 10V
Current, On-State Input, Min.	2 mA
Current, On-State Input, Nom.	4 mA (Field Power Supply Voltage = 24V dc)
Current, On-State Input, Max.	5 mA
Voltage, Off-State Input, Min.	Field Power Supply Voltage minus 5V
Voltage, Off-State Input, Max.	Equal to Field Power Supply Voltage
Current, Off-State Input, Max.	—
Input Impedance, Nom.	3.6 k Ω
Input Impedance, Max.	4.7 k Ω
Input Filter Time, Nom.	0.5 ms
Field Power Bus Supply Voltage, Min.	10V dc
Field Power Bus Supply Voltage, Nom.	24V dc
Field Power Bus Supply Voltage, Max.	28.8V dc

*Time between successive SSI words (Tp). Also called Dwell Time.

* Use this conductor category information for planning conductor routing as described in publication 1770-4.1, "Industrial Automation Wiring and Grounding Guidelines."

ArmorPoint I/O Counter Modules

Choose the ArmorPoint I/O high-speed counters when you need:

- **Intelligent counter modules** with their own microprocessors and I/O that are capable of reacting to high-frequency input signals up to 1 MHz.
- **Signals received at the inputs** to be filtered, decoded, and counted.
- **A pulse width modulated signal.** (1738-VHSC24M23 only)
- **Count and rate values** that can be used to activate up to two embedded outputs in less than 1 ms (1738-VHSC24M23 only).
- **Signals that are also processed** to generate rate and time-between pulses (pulse interval) data.

Counter Modules Specifications

	1738-IJM23	1738-VHSC24M23
Number of Counters	1	1
Keyswitch Position	2	2
Output Groups	—	1 group of 2
Input Frequency, Max.	1.0 MHz counter and encoder X1 configurations (no filter) 500 kHz encoder X2 configuration (no filter) 250 kHz encoder X4 configuration (no filter)	1.0 MHz counter and encoder X1 configurations (no filter) 500 kHz encoder X2 configuration (no filter) 250 kHz encoder X4 configuration (no filter)
Voltage, On-State Input, Nom.	5V dc	24V dc
Output Delay Time, OFF to ON	—	25 μ s (load dependent)*
Current, On-State Input, Min.	\geq 5 mA	\geq 5 mA
PointBus Current (mA)	160	110
Power Dissipation, Max.	1.1 W @ rated load	1.9 W @ rated load

*OFF to ON delay is time from a valid output "on" signal to output energization.

The counter modules serve as signal conditioners and function blocks, i.e., counters, between the customer process signals on the mounting base and the POINTBus backplane containing the command information. The three main functional blocks are the customer digital I/O interface, the counter ASIC, and the microprocessor.

The counter modules accept feedback from:

- encoders (single-ended or differential)
- pulse generators
- mechanical limit switches
- frequencies up to 1 MHz

A filter is available with four settings:

- 50 Hz
- 500 Hz
- 5 kHz
- 50 kHz

This filter can be turned off to achieve the fastest counting rate.

The input voltage range is 5V dc (1738-IJM23) or 15-24V dc (1738-VHSC24M23). The module returns the count (or frequency) in the form of a 24-bit binary number (0 to 16,777,215) expressed in a 32-bit word. Each counter has a user-selectable preset and rollover value associated with it.

The counter modules operate in the following modes:

- counter mode - read incoming single-phase pulses, return a binary count
- encoder mode - read incoming two-phase quadrature pulses, return a binary count
- period/rate mode - count internal clocks during the on period, return a frequency (1738-VHSC24M23 outputs are updated only at the end of the period)
- continuous/rate mode - count internal clocks during the on period, return a frequency (1738-VHSC24M23 outputs are updated continuously during this period)
- rate measurement mode - read pulses during the sample period, return a frequency
- pulse width modulation (PWM) mode - generate a pulse width modulated signal (1738-VHSC24M23)
- pulse generator mode - generates a pulse of defined width, returns width and quantity of trigger (1738-VHSC24M23 only)

The operation of the counter and encoder modes is nearly identical. The difference between the two modes is in the type of feedback (one-phase versus two-phase) for the count direction (up or down). In encoder mode, a transition is expected on the B input for counting to proceed in a direction, whereas, in counter mode, the B input may be left at a static level. All operating modes are selected by writing appropriate configuration data to the module.

1738-IJM23 Specifications

	1738-IJM23
Voltage Category/Type, Input	—
Current, Off-State Input, Max.	≤0.250 mA
Voltage, Off-State Input, Max.	≤1.25V dc
Current, On-State Input, Max.	25.7 mA @ 6V dc 19.1 mA @ 5V dc
Voltage, On-State Input, Min.	≥2.6V dc
Voltage, On-State Input, Max.	≥2.6V dc
Input Filter Selections, per A/B/Z group	Off 10 μs (50 kHz) 100 μs (5 kHz) 1.0 ms (500 Hz) 10.0 ms (50 Hz)
Keyswitch Position	2
Thermal Dissipation, Max.	3.75 BTU/hr @ rated load
Isolation Voltage, Min.	Prequalified at 1250V ac/rms between: System side Chassis ground A/B/Z inputs
External DC Power Supply Voltage, Nom.	No additional external power required to power module.

1738-VHSC24M23 Specifications

1738-VHSC24M23	
Voltage Category/Type, Input	24V dc
Current, Off-State Input, Max.	≤0.250 mA
Voltage, Off-State Input, Max.	≤1.8V dc
Current, On-State Input, Max.	10.2 mA @ 24V dc or 6.1 mA @ 15V dc
Voltage, On-State Input, Min.	≥12.5V dc
Input Filter Selections	Off 10 μs (50 kHz) 100 μs (5 kHz) 1.0 ms (500 Hz) 10.0 ms (50 Hz)
Input Frequency, Max.	1.0 MHz counter and encoder X1 configurations (no filter) 500 kHz encoder X2 configuration (no filter) 250 kHz encoder X4 configuration (no filter)
Keyswitch Position	2
Thermal Dissipation, Max.	6.5 BTU/hr @ rated load
Isolation Voltage, Min.	Prequalified for 1250V ac/rms between: Module 1 System side (PointBus) Chassis ground A/B/Z inputs 00/01 and user power supply Module 2 System side Chassis ground Vaux ± User power supply common
External DC Power Supply Voltage, Nom.	None required

1738-VHSC24M23 Input Derating Curve

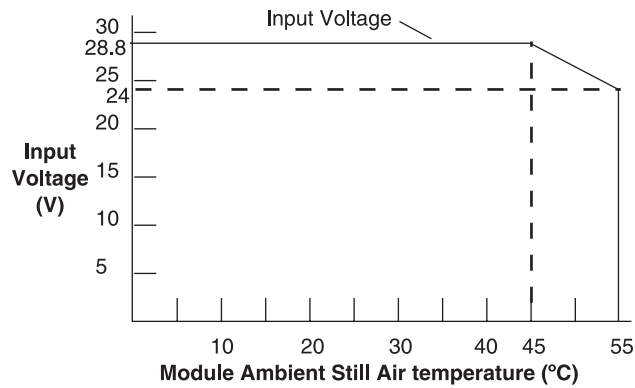

Note: Exceeding the maximum input voltage can cause permanent damage to the input.

Step 3 - Select:

- *the appropriate power unit*

Selecting a Power Supply Unit

ArmorPoint I/O adapters have built-in POINTBus power supplies. All ArmorPoint I/O modules are powered from the POINTBus by either an adapter or expansion power supply.

Power Specifications

Cat. No.	Power Supply Input Voltage, Nom.	Operating Voltage Range	Field Side Power Requirements, Max.	Power Supply Inrush Current, Max.	Overvoltage Protection, Inputs	Power Supply Interruption Protection
1738-ADN12	24V dc	10...28.8V dc	24V dc (+20% = 28.8V dc) @ 400 mA	6 A for 10 ms	Reverse polarity protected	Output voltage will stay within specifications when input drops out for 10 ms at 10V with max. load.
1738-ADN18						
1738-ADN18P						
1738-ADNX						
1738-ACNR						
1738-AENT						
1738-APB						
1738-EP24DC						

Power units are divided into three categories:

- Communication adapters with built-in power supply (dc-dc)
- Field power distributor
- Expansion power supply

Field Power Distributor

The 1738-FPD field power distributor passes through all ArmorPoint I/O backplane signals, but does not provide additional POINTBus backplane power. The field power distributor gives you the ability to change the field power distribution source for I/O modules to the right of the 1738-FPD field power distributor. This facilitates logical or functional partitioning of low-channel count, high I/O-mix applications using any of the communication adapters.

You can use the 1738-FPD field power distributor with a broad range of voltage inputs including 5V dc to 250V dc and/or 24V ac to 240V ac applications and I/O modules.

- Field-side voltage distribution module
- AC or DC input
- For use with all communication interfaces
- Partitioning (auxiliary power, major motion, minor motion, etc.)
- Starts new voltage distribution point

Consider using the 1738-FPD module to isolate field power segments.

Expansion Power Unit

The 1738-EP24DC expansion power unit passes 24V dc field power to the I/O modules to the right of it. This unit extends the backplane bus power and creates a new field voltage partition segment for driving field devices for up to 17 I/O modules. The expansion power unit separates field power from I/O modules to the left of the unit, effectively providing functional and logical partitioning for:

- separating field power between input and output modules
- separating field power to the analog and digital modules
- grouping modules to perform a specific task or function

You can use multiple expansion power units with any of the communication adapters to assemble a full system. If you are using the 1738-ADN12 adapter, you may use a 1738-EP24DC expansion power unit to add additional modules. For example, if you had a 36 module system with a 1738-ADN12 adapter, you would have at least two or more 1738-EP24DC expansion power units to provide more POINTBus current for modules to the right of the supply.

- 24V dc to 5V dc converter
- 1.3A, 5V dc output (extend backplane power)
- Starts new voltage distribution
- Partitioning

1738-EP24DC Current Derating for Mounting

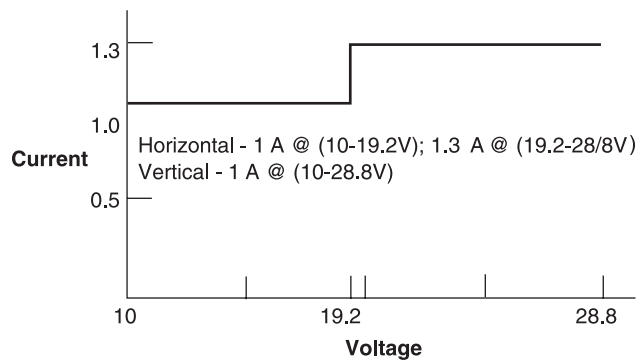

Power Distribution General Specifications

	1738-FPD	1738-EP24DC
Power Supply Requirements	—	Note: In order to comply with CE Low Voltage Directives (LVD), you must use a Safety Extra Low Voltage (SELV) or a Protected Extra Low Voltage (PELV) power supply to power this adapter
Field Side Power Requirements, Max.	24V dc (+20% = 28.8V dc max.) @ 400 mA	24V dc (+20% = 28.8V dc max.) @ 400 mA
Inrush Current, Max.	—	6 A for 10 ms
Overvoltage Protection, Inputs	Reverse polarity protected	Reverse polarity protected
Power Supply Interruption Protection	—	Output voltage will stay within specifications when input drops out for 10 ms at 10V with max load
Power Supply Input Voltage, Nom.	12V/24V dc 120V/220V ac	24V dc
Operating Voltage Range	10...28.8V dc 120V/240V ac	10...28.8V dc
Power Consumption, Max.	—	9.8 W @ 28.8V dc
Power Dissipation, Max.	—	3.0 W @ 28.8V dc
Thermal Dissipation, Max.	—	10.0 BTU/hr @ 28.8V dc
Isolation Voltage	1528V rms	1250V rms
Field Power Bus Supply Voltage, Nom.	12V dc, 24V dc, (10...28.8V dc range) 120V ac, 240V ac 50/60 Hz	12V dc or 24V dc
Field Power Bus Supply Current, Max.	10 A	10 A

Typical Configurations

Power Distribution Options

ArmorPoint Communication Adapter and I/O Modules

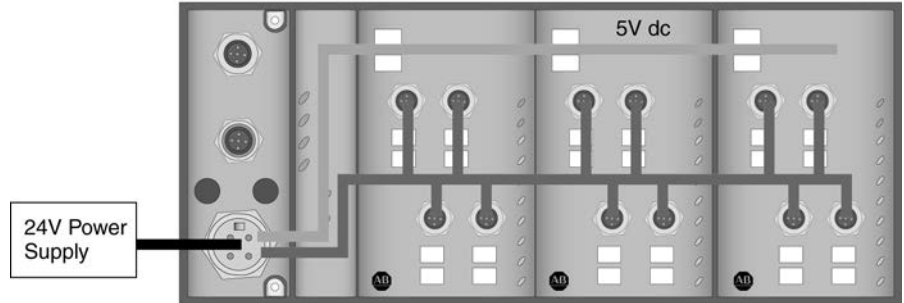

An auxiliary 24V dc power supply provides power to the POINTBus backplane and I/O modules. You can connect up to 17 I/O modules and an adapter with a maximum of 10 A field power, using the auxiliary power.

ArmorPoint I/O System with Field Power Distributor (1738-FPD)

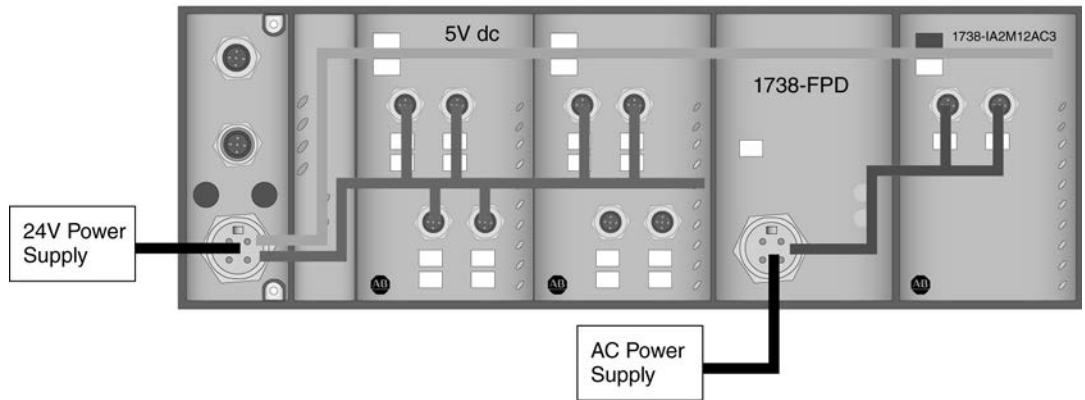

The ArmorPoint field power distributor (1738-FPD) discontinues the I/O circuit power bus in order to change the field power source for I/O modules to the right of it. This allows a broad range of voltage inputs in the I/O assembly.

ArmorPoint I/O System with 24V dc Expansion Power Unit (1738-EP24DC)

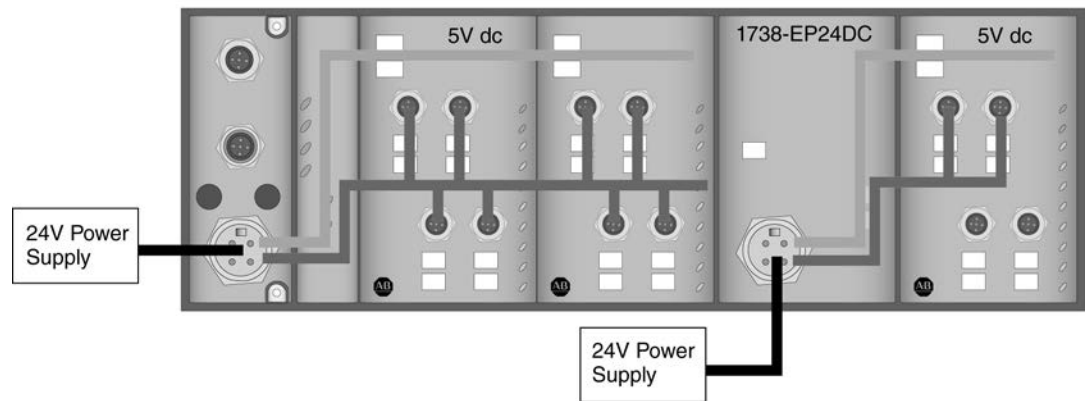

The auxiliary power supports up to 17 I/O modules and an adapter with a maximum of 10 A field power. The 24V dc expansion power unit (1738-EP24DC) extends the backplane bus power to support up to 17 more I/O modules. Connect additional expansion power units to expand the I/O assembly up to the maximum of 63 I/O modules.

Step 4 - Select:

- optional accessories, cables, and cordsets

Selecting Optional Accessories

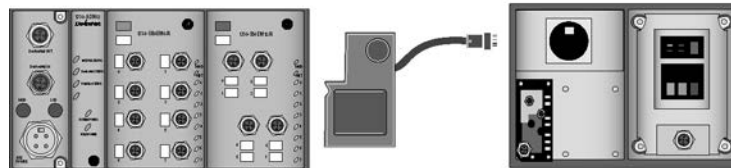
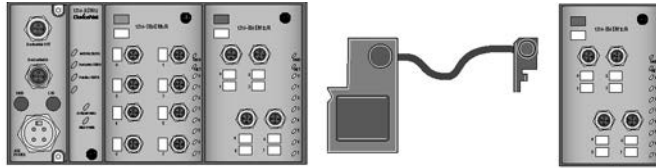

Any network adapter

Bus Extenders

ArmorStart

Accessories, Cables and Cordsets

ArmorPoint Bus Extension Bases

Cat. No.	Description
1738-EXT1	ArmorPoint 1 meter bus extension unit
1738-EXT3	ArmorPoint 3 meter bus extension unit

The following rules apply for the 1738-EXT1 and -EXT3 extension units.

- Use as many as four extension units per network adapter, except the 1738-ADNX adapter.
- Use only one extension unit with the 1738-ADNX adapter if there are fewer than 32 modules on the backplane.
- You must use a 1738-EP24DC or -FPD module immediately after an extension unit:

Use a 1738-EP24DC module if you need additional backplane power because of module current consumption or after two extension units.

Use a 1738-FPD module for almost all other configurations. The exception is if the modules in the segment after the extension unit are 1738-IT2IM12, -IR2M12, -OW4M12, or -OW4M12AC modules, in which case the 1734-FPD is not necessary.

- Do not exceed the rated adapter or 1734-EP24DC module current. Otherwise, the number or mix of modules used between extension cables does not matter.

Cables and Cordsets

For additional information on selecting cables and cordsets for ArmorPoint I/O see:

- On-Machine Connectivity Catalog, publication M115-CA001
- On-Machine Solutions Selection Guide, publication ONMACH-SG001

ArmorPoint Digital Input Module Cables

Cat. No.	For Using:	Recommended Patchcord (double-ended)	Recommended Male Cordset (single-ended)
1738-IB2M12	—	889D-F4ACDM-x	889D-M4AC-y
1738-IB4M8	3-pin pico connectors	889P-F3ABPM-x	889P-M3AB-y
	4-pin pico connectors	889P-F4ABPM3-x	
1738-IB4M12	—	889D-F4ACDM-x	889D-M4AC-y
1738-IB8M8	3-pin pico connectors	889P-F3ABPM-x	889P-M3AB-y
1738-IV8M8	4-pin pico connectors	889P-F4ABPM3-x	
1738-IB8M12	2 inputs per connector	879D-F4ACDM-x	879-C3AEDM4-5
1738-IV8M12	1 input per connector	889D-F4ACDM-x	889D-M4AC-y
1738-IB8M23	—	889M-F12AHMU-z	—
1738-IV8M23			

x = length in meters (1, 2, 3, 5, and 10 standard).
y = length in meters (2, 5, and 10 standard).
z = length in meters (1, 2, and 3 standard)

ArmorPoint Digital Output Module Cables

Cat. No.	For Using:	Recommended Patchcord (double-ended)	Recommended Male Cordset (single-ended)
1738-OB2EM12	—	889D-F4ACDM-x	889D-M4AC-y
1738-OB2EPM12	—	889D-F4ACDM-x	889D-M4AC-y
1738-OB4EM8	3-pin pico connectors	889P-F3ABPM-x	889P-M3AB-y
	4-pin pico connectors	889P-F4ABPM3-x	
1738-OB4EM12	—	889D-F4ACDM-x	889D-M4AC-y
1738-OV4EM12	—	889D-F4ACDM-x	889D-M4AC-y
1738-OB8EM8	3-pin pico connectors	889P-F3ABPM-x	889P-M3AB-y
	4-pin pico connectors	889P-F4ABPM3-x	
1738-OB8EM12	2 inputs per connector	879D-F4ACDM-x	879-C3AEDM4-5
	1 input per connector	889D-F4ACDM-x	889D-M4AC-y
1738-OB8EM23	—	889M-F12AHMU-z	—

x = length in meters (1, 2, 3, 5, and 10 standard).
y = length in meters (2, 5, and 10 standard).

ArmorPoint Analog Module Cables

Cat. No.	Recommended Patchcord (double-ended)	Recommended Male Cordset (single-ended)
1738-IE2CM12	—	—
1738-IE2VM12	—	—
1738-OE2CM12	—	—
1738-OE2VM12	—	—

ArmorPoint AC and Relay Module Cables

Cat. No.	Recommended Patchcord (double-ended)	Recommended Male Cordset (single-ended)
1738-OW4M12	889D-F4ACDM-x	889D-M4AC-y
1738-OW4M12AC4	889R-F4AERM-x	889R-M4AE-y
1738-IA2M12AC3	889R-F3AERM-x	889R-M3AEA-y
1738-IA2M12AC4	889R-F4AERM-x	889R-M4AE-y
1738-OA2M12AC3	889R-F3AERM-x	889R-M3AEA-y

x = length in meters (1, 2, 3, 5, and 10 standard).

y = length in meters (2, 5, and 10 standard).

ArmorPoint Specialty Module Cables

Cat. No.	Recommended Patchcord (double-ended)	Recommended Male Cordset (single-ended)
1738-232ASCM12	889D-F4ACDM-x	889D-M4AC-y
1738-485ASCM12		
1738-IR2M12		
1738-VHSC24M23	889M-F12AHMU-z	—
1738-IJM23		
1738-SSIM23		

x = length in meters (1, 2, 3, 5, and 10 standard).

y = length in meters (2, 5, and 10 standard).

z = length in meters (1, 2, and 3 standard).

ArmorPoint Thermocouple Terminal Chambers

Cat. No.	Straight	Right Angle
1738-IT2IM12	871A-TS4CJC-DM	871A-TR4CJC-DM

ArmorPoint DeviceNet and Auxiliary Power Cables

Cat. No.	Network	Recommended Network Cable	Recommended Auxiliary Power Cables
1738-ADNX	DeviceNet	KwikLink Flat Media system standard drop cable: 1485K-PzF5-R5 Thick Round system standard drop cable: 1485R-PzM5-R5 Thin Round system standard drop or trunk: 1485R-PzR5-D5	Standard Cordset (single-ended): 889N-F4AFC-yF Standard Patchcord (double-ended): 889N-F4AFNM-x
1738-ADN12 1738-ADN18 1738-ADN18P	DeviceNet	KwikLink Flat Media system standard drop cable: 1485K-PzF5-R5 Thin Round system standard drop cable: 1485R-PzN5-M5 Thick Round system standard drop cable: 1485C-PzN5-M5	
1738-ACNR	ControlNet	—	
1738-AENT	EtherNet/IP	—	
1738-APB	PROFIBUS DP	—	Standard Cordset (single-ended): 889N-F5AFC-y

x = length in meters (1, 2, 3, and 6 standard).
 y = length in feet (6, 12, and 20 standard).
 z = length in feet (1, 2, 3, 4, 5, and 6 standard).

Step 5 - Select:

Determining Mounting Requirements

Placing ArmorPoint I/O Modules

The producer/consumer model multicasts messages. This means that multiple nodes can consume the same data at the same time from a single device. Where you place I/O modules in the control system determines how the modules exchange data.

For a Rockwell controller to control ArmorPoint I/O, the I/O must be:

- on the same network as the controller **or**
- on a ControlNet network that is local to that controller **or**
- on an EtherNet/IP network that is local to that controller

Maximum Size Layout

	POINTBus Current (mA)	Maximum I/O Modules with 24V dc Backplane Current at 75 mA each	Maximum I/O Modules with Expansion Power Supplies	Maximum Number of I/O Module Connections
1738-ADN12 on DeviceNet	1000	Up to 17	63	5 rack and 20 direct
1738-ADN18 on DeviceNet				
1738-ADN18P on DeviceNet				
1738-ADNX on DeviceNet				
1738-ACNR on ControlNet				
1738-AENT on EtherNet/IP				
1738-APB on PROFIBUS				20 total connections including rack and direct
1738-EP24DC Expansion Power	Not to exceed scanner capacity			
	Horizontal mounting: 1 A @ 5V dc for 10...19.2V input; 1.3 A @ 5V dc for 19.2...28.8V input Vertical mounting: 1 A @ 5V dc for 10...28.8V input			

Power Supply Distance Rating

Modules are placed to the right of the power supply. Each ArmorPoint I/O module can be placed in any of the slots to the right of the power supply until the usable backplane current of that supply has been exhausted. An adapter provides 1 A current to the POINTBus. The 1738-EP24DC provides up to 1.3 A and I/O modules require from 75 mA (typical for the digital and analog I/O modules) up to 220 mA or more.

POINTBus Current Requirements

Cat. No.	POINTBus Current Requirements
1738-IB2M12	75 mA
1738-IB4xxx	
1738-IB8xxx	
1738-IV4xxx	
1738-IV8xxx	
1738-OB2EM12	
1738-OB2EPM12	
1738-OB4Exxx	
1738-OB8Exxx	
1738-OV4EM12	
1738-OW4xxx	90 mA
1738-IE2CM12	75 mA
1738-OE2CM12	
1738-IE2VM12	
1738-OE2VM12	
1738-IA2xxx	
1738-OA2xxx	
1738-IJM23	160 mA
1738-SSIM23	110 mA
1738-IR2M12	220 mA
1738-IT2IM12	175 mA
1738-VHSC24M23	180 mA
1738-232ASCM12	75 mA
1738-485ASCM12	

Mounting the ArmorPoint I/O System

You can panel mount the ArmorPoint I/O system in the horizontal or vertical orientation.

ArmorPoint I/O with 1738-ADN12, -ADN18, -ADN18P, -ADNX, -ACNR, -AENT, -APB Mounting Dimensions

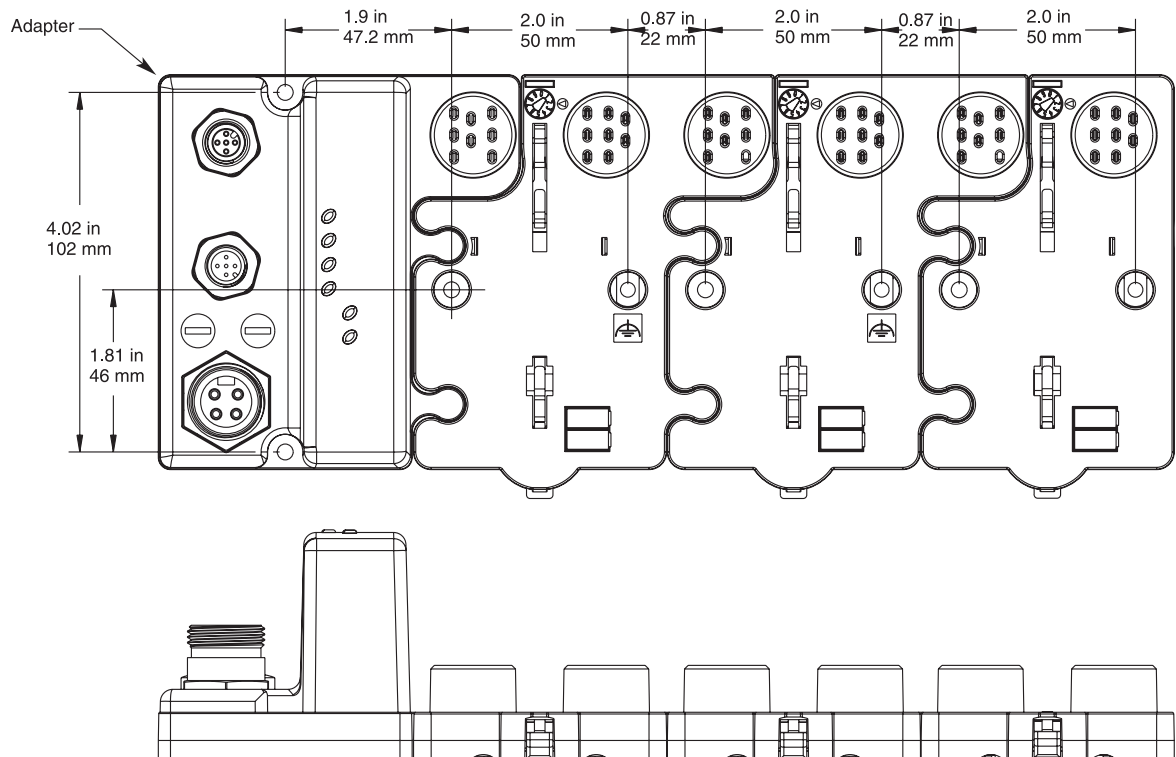

Related Documentation

Additional user documentation presents information according to the tasks you perform and the programming environment you use. Refer to the table below for information on 1738 ArmorPoint I/O products.

ArmorPoint I/O Related Publications*

	Cat. No.	Description	Pub.No.
General Information		DeviceNet Media (Media, Sensors and Distributed I/O) Catalog Guide	1485-CG001
		DeviceNet Adapter Quick Start	1734-QS002
		ControlNet Media	AG-PA002
		EtherNet/IP Performance and Application Guide	ENET-AP001
		Industrial Automation Wiring and Grounding Guidelines	1770-4.1
		Allen-Bradley Terminal Marking System Product Profile	1492-1.18
		Literature Library	http://www.rockwellautomation.com/literature
Pinout Wiring Diagrams	1738-IB2M12, -IB4EM8, -IB4M12, -IB8M12, -IB8M23, -IB8M8, -IV4M12, -OB2EPM12, -OB4EM12, -OB4EM8, -OB8EM8, -OV4EM12, -OB8EM12	Pinout Guide for 1738 ArmorPoint Digital I/O Modules	1738-WD001
	1738-IA2M12AC3, -IA2M12AC4, -OA2M12AC3, -OW2M12, -OW2M12AC	Pinout Guide for 1738 ArmorPoint AC and Relay Modules	1738-WD002
	1738-232ASCM12, -485ASCM12, -IE2CM12, -IE2VM12, -IJM23, -IR2M12, -IT2IM12, -OE2CM12, -OE2VM12, -SSIM23, -VHSC24M23	Pinout Guide for 1738 ArmorPoint Analog, Serial, Encoder/Counter Modules	1738-WD003
	1738-ADN12, -ADN18, -ADN18P, -ADNX, -ACNR, -APB, -AENT, -EP24DC, -FPD	Pinout Guide for 1738 ArmorPoint Adapters and Power Supplies	1738-WD004
Communication Interfaces	1738-ADN12	ArmorPoint DeviceNet Adapter Module, Drop or Pass-through, with male and female M12 connectors	1738-IN014
	1738-ADN18	ArmorPoint DeviceNet Adapter Module, Drop only, with male M18 connector	
	1738-ADN18P	ArmorPoint DeviceNet Adapter Module, Drop or Pass-through, with male and female M18 connectors	
	1738-ADNX	ArmorPoint DeviceNet 24V dc Adapter Module with subnet expansion	
	1738-ACNR	ArmorPoint Redundant ControlNet Adapter Module	1738-IN016
	1738-AENT	ArmorPoint Ethernet/IP 10/100 Mbps Adapter Module	1738-IN017
	1738-APB	ArmorPoint PROFIBUS Adapter Module	1738-IN015
AC	1738-IA2M12AC3	120V ac 2 Input w/ 2 AC 3 pin M12 connections	1738-IN006
	1738-IA2M12AC4	120V ac 2 Input w/ 2 AC 4 pin M12 connectors	1738-IN006
	1738-OA2M12AC3	120/230V ac 2 Output w/ 2 AC 3 pin M12 connectors	1738-IN007
DC	1738-IB2M12	24V dc 2 Sink Input w/ 2 M12 connectors	1738-IN002
	1738-IB4M12	24V dc 4 Input w/ 4 M12 connectors	
	1738-IB4M8	24V dc 4 Sink Input w/ 4 M8 connectors	
	1738-IB8M12	24V dc 8 Sink Input w/ 4 M12 connectors, 2 points per connector	
	1738-IB8M23	24V dc 8 Sink Input w/ 1 M23 connector	
	1738-IB8M8	24V dc 8 Sink Input w/ 8 M8 connectors	
	1738-OB2EM12	24V dc 2 Source Output w/ 2 M12 connectors	1738-IN001
	1738-OB2EPM12	24V dc 2 Source Output - 2A Prot. w/ 2 M12 connectors	
	1738-OB4EM12	24V dc 4 Source Output w/4 M12	
	1738-OB4EM8	24V dc 4 Source Output w/ 4 M8 connectors	
	1738-OB8EM12	24V dc 8 Source Output w/ 8 M12	
	1738-OB8EM8	24V dc 8 Source Output w/ 8 M8	

* Contact your local A-B distributor for information on ordering any of the above publications. For electronic copies of these publications, go to: <http://www.rockwellautomation.com/literature>

ArmorPoint I/O Related Publications*

	Cat. No.	Description	Pub.No.
Analog	1738-IE2CM12	24V dc Analog Current Input w/ 2 M12 connectors	1738-IN003
	1738-IE2VM12	24V dc 2 Analog Voltage Input w/ 2 M12 connectors	
	1738-OE2CM12	24V dc Analog Current Output w/ 2 M12 connectors	1738-IN004
	1738-OE2VM12	24V dc Analog Voltage Output w/ 2 M12 connectors	
	1738-IR2M12	24V dc 2 RTD Input	1738-IN005
	1738-IT2IM12	24V dc 2 Thermocouple Input	
Serial Interface Modules	1738-232ASCM12	ArmorPoint I/O RS-232 ASCII Serial Interface Module	1738-IN009
	1738-485ASCM12	ArmorPoint I/O RS-485 ASCII Serial Interface Module†	1738-IN010
	1738-SSIM23	ArmorPoint Synchronous Serial Interface Module with Absolute Encoder	1738-IN013
Counters	1738-IJM23	ArmorPoint 5V Encoder/Counter Module	1738-IN012
	1738-VHSC24M23	24V dc Very High Speed Counter Module	1738-IN011
Power Units	1738-FPD	ArmorPoint I/O Field Potential Distributor Module	1738-IN019
	1738-EP24DC	24V dc Expansion Power Supply	1738-IN020

* Contact your local A-B distributor for information on ordering any of the above publications.
 For electronic copies of these publications, go to: <http://www.rockwellautomation.com/literature>

The following are trademarks of Rockwell Automation: ArmorPoint, POINTBus, PLC-5, SLC 500, Logix, NetLinX, PanelView, RSLinx, RSNetWorX, and SoftLogix.

Trademarks not belonging to Rockwell Automation are property of their respective companies.

www.rockwellautomation.com

Power, Control and Information Solutions Headquarters

Americas: Rockwell Automation, 1201 South Second Street, Milwaukee, WI 53204-2496 USA, Tel: (1) 414.382.2000, Fax: (1) 414.382.4444

Europe/Middle East/Africa: Rockwell Automation, Vorstlaan/Boulevard du Souverain 36, 1170 Brussels, Belgium, Tel: (32) 2 663 0600, Fax: (32) 2 663 0640

Asia Pacific: Rockwell Automation, Level 14, Core F, Cyberport 3, 100 Cyberport Road, Hong Kong, Tel: (852) 2887 4788, Fax: (852) 2508 1846